

SOT-23 Plastic-Encapsulate Diodes

BAS70/-04/-05/-06 SWITCHING DIODE

FEATURES

- Low turn-on voltage
- Fast switching
- Also available in lead free version

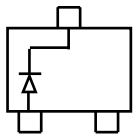
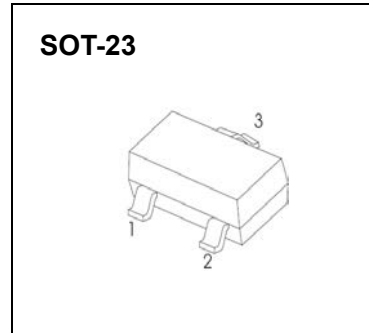

BAS70 Marking: 73

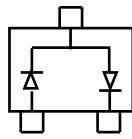

BAS70-04 Marking: 74

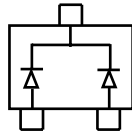



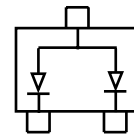





BAS70-05 Marking: 75



BAS70-06 Marking: 76

MARKING:

BAS70	BAS70-04	BAS70-05	BAS70-06
 	 	 	 

Solid dot = Green molding compound device, if none, the normal device.

MAXIMUM RATINGS @T_a=25°C

Symbol	Parameter	Value	Unit
V _R	DC Voltage	70	V
I _F	Forward Continuous Current	70	mA
I _{FSM}	Non-Repetitive Peak Forward Surge Current @ t = 8.3ms	100	mA
P _D	Power Dissipation	200	mW
R _{θJA}	Thermal Resistance Junction to Ambient	500	°C/W
T _J	Operating Junction Temperature Range	-40 ~ +125	°C
T _{stg}	Storage Temperature Range	-55 ~ +150	°C

ELECTRICAL CHARACTERISTICS (T_a=25°C unless otherwise specified)

Parameter	Symbol	Test conditions	Min	Max	Unit
Reverse breakdown voltage	V _(BR)	I _R = 10μA	70		V
Reverse voltage leakage current	I _R	V _R =50V		100	nA
Forward voltage	V _F	I _F =1mA I _F =15mA		410 1000	mV
Diode capacitance	C _D	V _R =0V f=1MHz		2	pF
Reverse recovery time	t _{rr}	I _F =I _R =10mA, I _{rr} =0.1I _R , R _L =100Ω		5	ns

Typical Characteristics

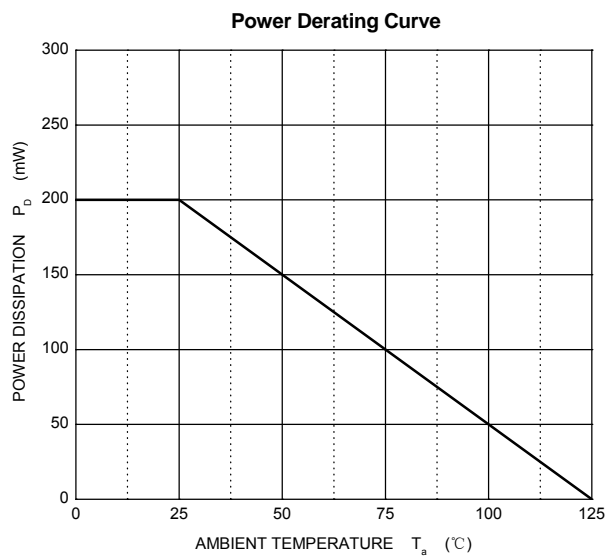
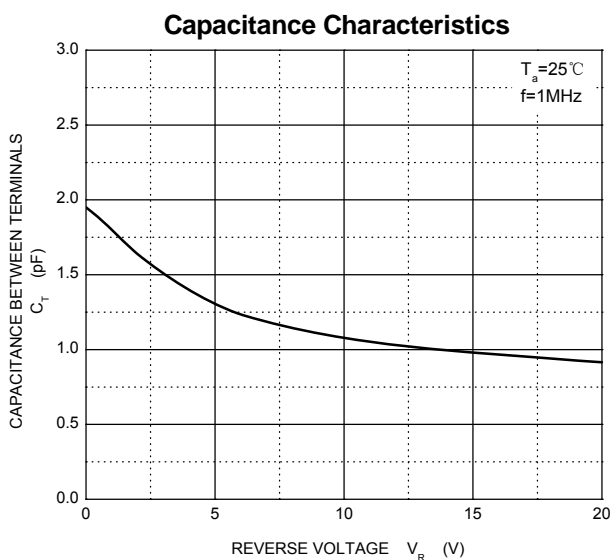
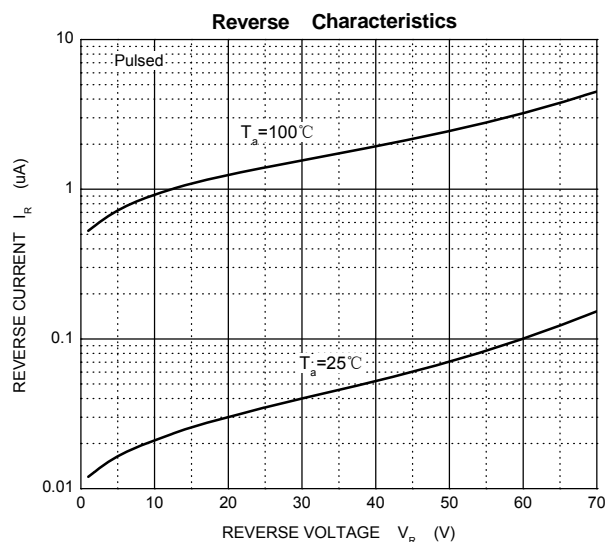
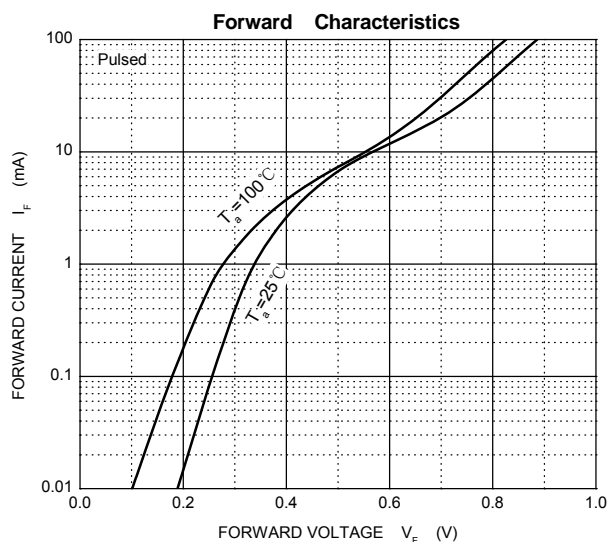

SOT-23 Package Outline Dimensions

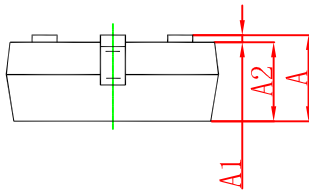
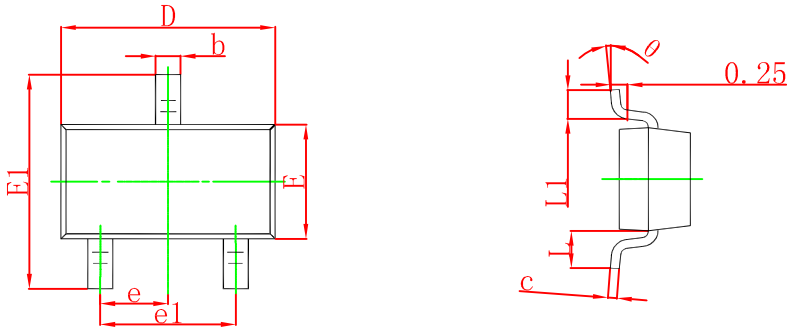

Symbol	Dimensions In Millimeters		Dimensions In Inches	
	Min	Max	Min	Max
A	0.900	1.150	0.035	0.045
A1	0.000	0.100	0.000	0.004
A2	0.900	1.050	0.035	0.041
b	0.300	0.500	0.012	0.020
c	0.080	0.150	0.003	0.006
D	2.800	3.000	0.110	0.118
E	1.200	1.400	0.047	0.055
E1	2.250	2.550	0.089	0.100
e	0.950 TYP		0.037 TYP	
e1	1.800	2.000	0.071	0.079
L	0.550 REF		0.022 REF	
L1	0.300	0.500	0.012	0.020
θ	0°	8°	0°	8°

SOT-23 Suggested Pad Layout

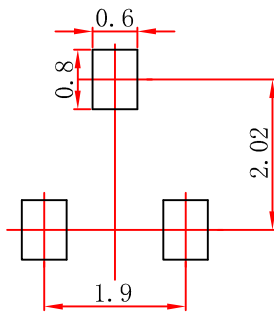

Note:

1. Controlling dimension: in millimeters.
2. General tolerance: $\pm 0.05\text{mm}$.
3. The pad layout is for reference purposes only.

NOTICE

JSCJ reserves the right to make modifications, enhancements, improvements, corrections or other changes without further notice to any product herein. JSCJ does not assume any liability arising out of the application or use of any product described herein.

SOT-23 Tape and Reel

SOT-23 Embossed Carrier Tape

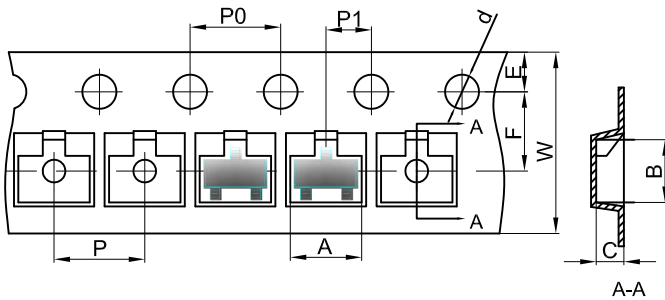

Packaging Description:

SOT-23 parts are shipped in tape. The carrier tape is made from a dissipative (carbon filled) polycarbonate resin. The cover tape is a multilayer film (Heat Activated Adhesive in nature) primarily composed of polyester film, adhesive layer, sealant, and anti-static sprayed agent. These reeled parts in standard option are shipped with 3,000 units per 7" or 17.8cm diameter reel. The reels are clear in color and is made of polystyrene plastic (anti-static coated).

Dimensions are in millimeter

Pkg type	A	B	C	d	E	F	P0	P	P1	W
SOT-23	3.15	2.77	1.22	Ø1.50	1.75	3.50	4.00	4.00	2.00	8.00

SOT-23 Tape Leader and Trailer

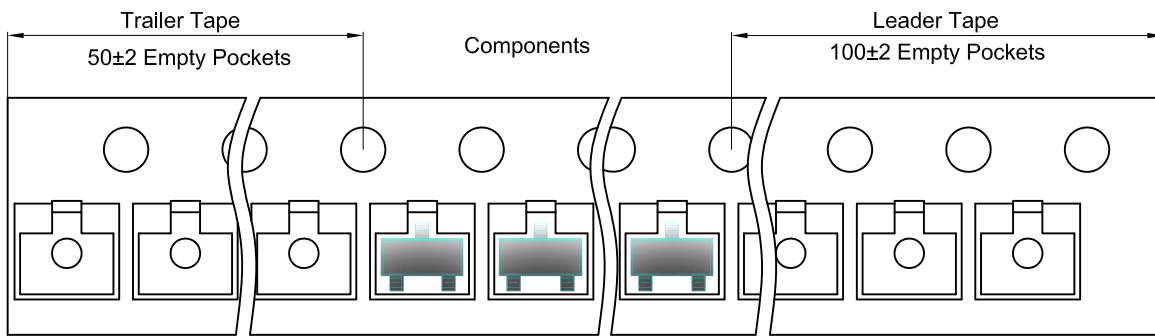

SOT-23 Reel

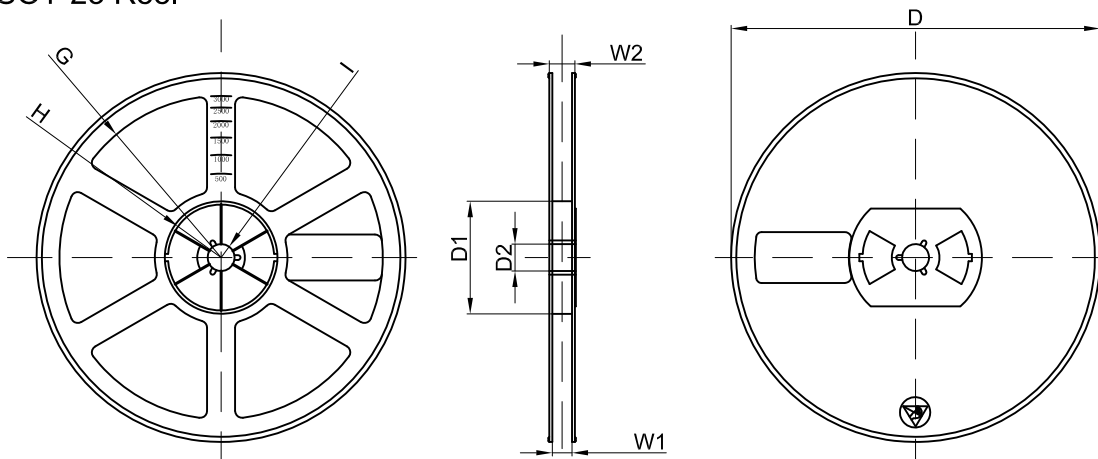

Dimensions are in millimeter

Reel Option	D	D1	D2	G	H	I	W1	W2
7"Dia	Ø178.00	54.40	13.00	R78.00	R25.60	R6.50	9.50	12.30

REEL	Reel Size	Box	Box Size(mm)	Carton	Carton Size(mm)	G.W.(kg)
3000 pcs	7 inch	45,000 pcs	203×203×195	180,000 pcs	438×438×220	